

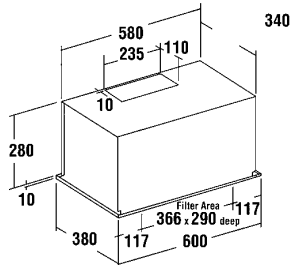

QASAIR ELITE RANGE

ECH-600-1-T/B



1. QASAIR has the two essential features:
 - high air movement;
 - low noise level.
2. QASAIR Rangehoods are designed to work efficiently and effectively in Australian kitchens.
3. QASAIR Rangehoods are fitted with an all-metal fan and motor.
4. All motors have a thermal cut out.
5. All rangehoods have a capacitor start.

ECH-800-1-T/B

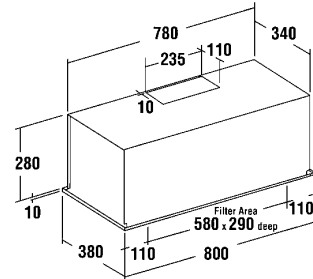

ECH-800-2-T/B

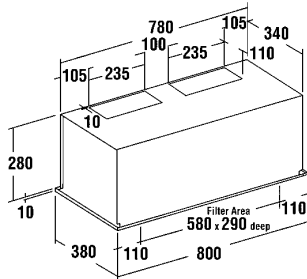

ECH-900-1-T/B

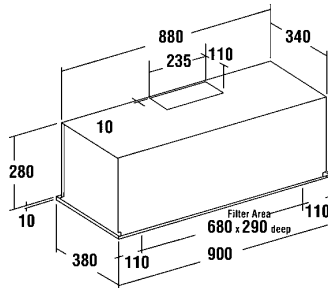

ECH-900-2-T/B

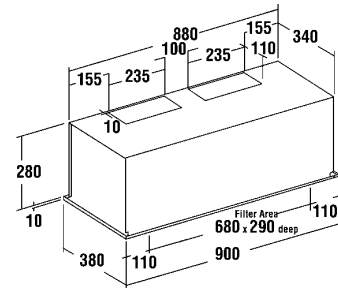

ECH-1000-2-T/B

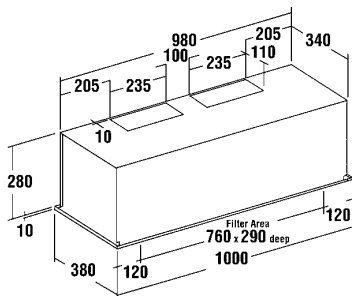

6. All rangehoods must be ducted to the outside atmosphere in non-flammable material and all joints sealed to ensure smoke and odour cannot escape back into the home.
7. QASAIR Rangehoods with one motor have an air movement of 450 - 900 cubic metres per hour; and hoods with two motors have an air movement from between 450 - 1800 cubic metres per hour.
8. QASAIR Rangehoods are fitted with low voltage halogen lights, and removable, dishwasher-safe filters.

ECH-1200-2-T/B

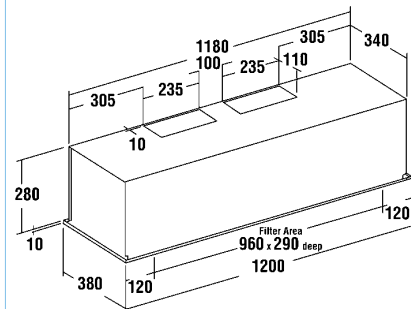

AVAILABLE FROM THE FOLLOWING ELITE APPLIANCES STORES

ARMADALE

729 High Street
Armadale Victoria 3143
T 03 9500 2424

ABBOTSFORD

335 Johnston Street
Abbotsford Victoria 3067
T 03 9417 7599

HAWTHORN

632 Burwood Road
Hawthorn Victoria 3122
T 03 9813 4399

QASAIR rangehoods are designed and made to remove the by-products of cooking.

1 – Heat Which consists of expanded air molecules that move rapidly in both an upward and outward pattern

2 – Steam The act of cooking expands water molecules almost 1800 times as they become steam. As this vapour escapes it carries grease and odours that are absorbed into furnishings, walls and clothing

3 – Grease Vapourised cooking grease is the major problem in cooking. This grease is organic matter which settles on every surface causing discolouration and an unsightly mess

4 – Odours These cling to walls and furnishings and the only real solution is to duct them to the outside atmosphere

QASAIR RANGEHOODS MADE IN RINGWOOD 3134

QASAIR reserves the right to change specification without notice. ® is a registered Trade Mark.